

### DESCRIZIONE / DESCRIPTION

Elettrovalvola a cartuccia 3 vie 2 posizioni a cursore, azionamento diretto.  
3 way 2 position spool type, solenoid operated cartridge valves, direct acting.

### TIPO / TYPE

**EVM22 32A1**

### SIMBOLO / SYMBOL

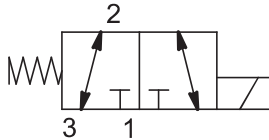

### SPECIFICHE / SPECIFICATION

Cavità Cavity	C 2215 - 3
Pressione max. Max. Op. pressure	310 bar
Portata max. Max Flow	35 l/min
Trafilamento interno Internal Leakage	Max. 50 cm <sup>3</sup> /min a 310 bar con Oil 32 cSt
Blocchetti Standard Standard Manifolds	Cap. 8
Bobine Coils	Cap. 6 - Size 09

### GRANDEZZA / SIZE

**M22**

### PRESTAZIONI / PERFORMANCE

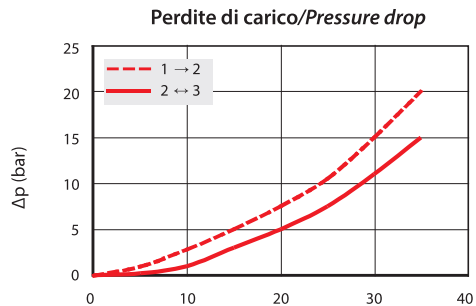
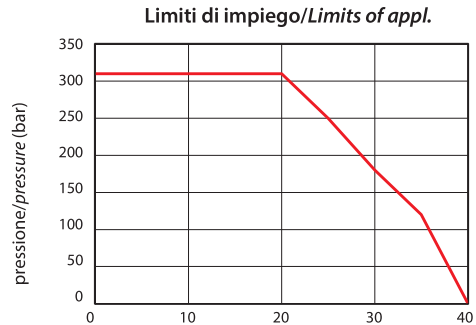

Olio idraulico minerale 32 cSt – temp. 40 °C [104 °F]  
Hydraulic mineral Oil 32 cSt – temp. 40 °C [104 °F]

### DIMENSIONI / DIMENSIONS

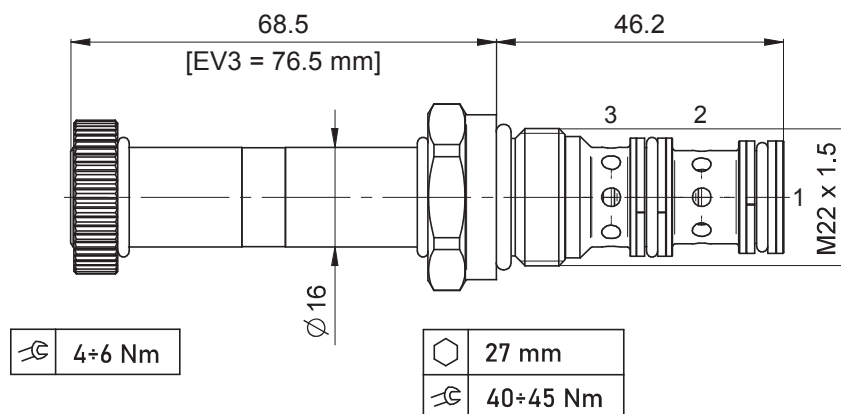

### INFORMAZIONI PER L'ORDINE / ORDERING INFORMATION

