

DESCRIZIONE / DESCRIPTION

Elettrovalvola a cartuccia 3 vie 2 posizioni a cursore, azionamento diretto.
3 way 2 position spool type, solenoid operated cartridge valves, direct acting.

TIPO / TYPE

EVM16 32A6

SIMBOLO / SYMBOL

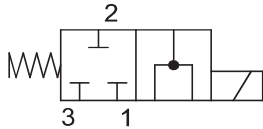

SPECIFICHE / SPECIFICATION

Cavità Cavity	C 1615 - 3
Pressione max. Max. Op. pressure	220 bar
Portata max. Max Flow	10 l/min
Trafilamento interno Internal Leakage	Max. 40 cm ³ /min a 220 bar con Oil 32 cSt
Blocchetti Standard Standard Manifolds	Cap. 8
Bobine Coils	Cap. 6 - Size 03

GRANDEZZA / SIZE

M16

PRESTAZIONI / PERFORMANCE

Limiti di impiego/Limits of appl.

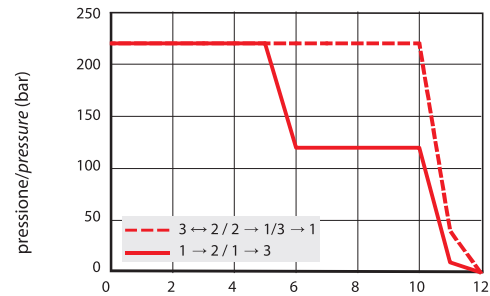

Perdite di carico/Pressure drop

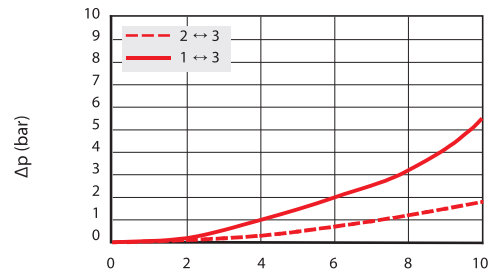

Olio idraulico minerale 32 cSt – temp. 40 °C [104 °F]
Hydraulic mineral Oil 32 cSt – temp. 40 °C [104 °F]

DIMENSIONI / DIMENSIONS

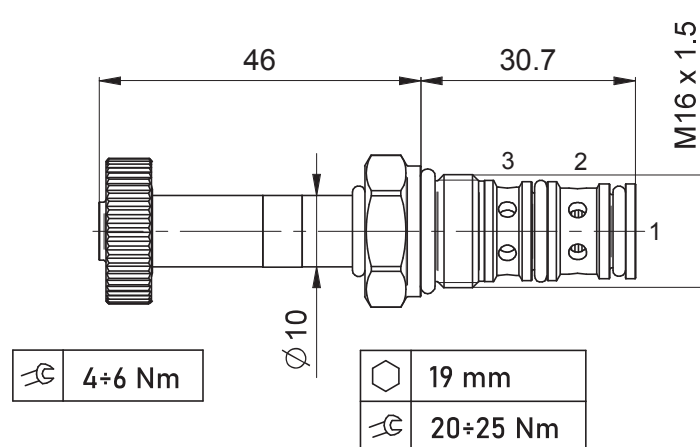

INFORMAZIONI PER L'ORDINE / ORDERING INFORMATION

